

Rotor-X Low Flow Sensor



3-2536.090-1



(B-4/98) English



SAFETY INSTRUCTIONS

1. Do not remove from pressurized lines.
2. Do not exceed maximum temperature/pressure specifications.
3. Do not install/service without following installation instructions (see sensor manual).
4. Wear safety goggles and faceshield during installation/service.
5. Do not alter product construction.
6. Failure to follow safety instructions could result in severe personal injury!

1. Location of Fitting

Recommended sensor upstream/downstream mounting requirements.

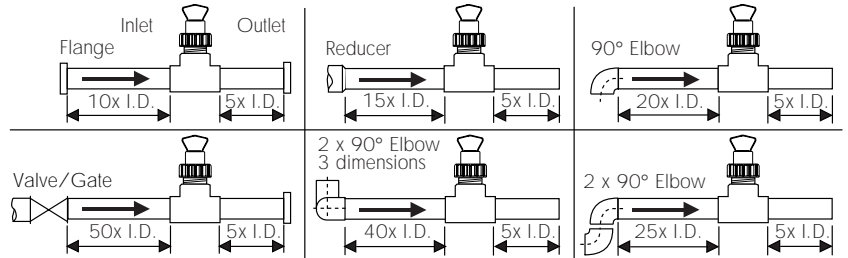

2. Sensor Mounting Position

- Horizontal pipe runs: Mount sensor in the upright (0°) position for best overall performance. Mount at a maximum of 45° when air bubbles are present. Do not mount on the bottom of the pipe when sediments are present.
- Vertical pipe runs: Sensor must be mounted in lines with UPWARD flow only.

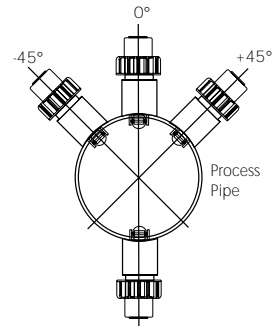

3. Sensor Wiring

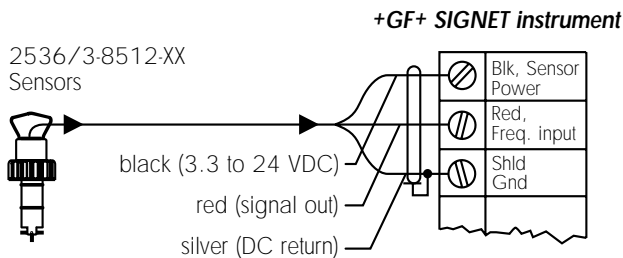

- Use 2-conductor shielded cable for cable extensions up to 300 m (1000 ft).
- Cable shield must be maintained through cable splice.
- +GF+ SIGNET Inteltek-Pro, use 2536 input card setting
- Refer to your instrument manual for specific wiring details.

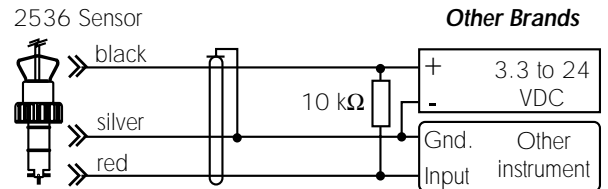

- Pull-up resistor required (10 kΩ recommended).
- Use 2-conductor shielded cable for cable extensions up to 300 m (1000 ft).
- Cable shield must be maintained through cable splice.

4. +GF+ SIGNET Fittings

| Type | Description |
|---------------------------------------|--|
| <p>Plastic tees</p> | <ul style="list-style-type: none"> • 0.5 to 4 in. versions • PVC or CPVC • Mounts via glue-on fittings |
| <p>PVC saddles</p> | <ul style="list-style-type: none"> • 2 to 4 in., cut 1-7/16 in. hole in pipe • 6 to 8 in., cut 2-1/4 in. hole in pipe • Align wedge arrows with saddle arrows during assembly. • Pipes over 8 in., use iron saddle |
| <p>Iron strap-on saddles</p> | <ul style="list-style-type: none"> • 2 to 4 in., cut 1-7/16 in. hole in pipe • Over 4 in., cut 2-1/4 in. hole in pipe • Special order over 12 in. |
| <p>Carbon steel weld-on weldolets</p> | <ul style="list-style-type: none"> • 2 to 4 in., cut 1-7/16 in. hole in pipe • Over 4 in., cut 2-1/4 in. hole in pipe • Remove insert before welding • Installed by certified welder only • Special order over 12 in. |
| <p>Carbon steel threaded tees</p> | <ul style="list-style-type: none"> • 0.5 to 2 in. versions • Mounts on threaded pipe ends |

| Type | Description |
|------|--|
| | <p>Metric plastic saddle</p> <ul style="list-style-type: none"> • For pipes DN 65 to 200 mm • Requires a 30 mm diam. hole in the pipe • Wedge and saddle arrows must match |
| | <p>Metric wafer fitting</p> <ul style="list-style-type: none"> • For pipes DN 65 to 200 mm • Follow the recommended installation guidelines |
| | <p>Metric union fitting</p> <ul style="list-style-type: none"> • For pipes from DN 15 to 50 mm • PP or PVDF • Follow the recommended installation guidelines |

5. H-Dimensions

The plastic sensor insert in the Weldolet fitting MUST be removed during the welding process. When reinstalled, it is important that the insert be threaded to the proper height ("H" dimension).

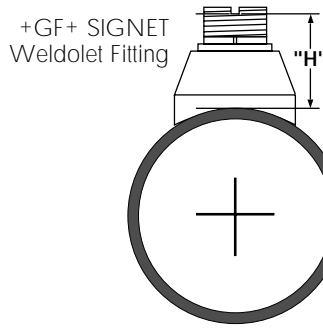

| Weldolet part number | "H" dimension inches | mm | Weldolet part number | "H" dimension inches | mm |
|----------------------|----------------------|--------|----------------------|----------------------|--------|
| CS4W020 | 2.38 | 60.45 | CS4W240 | 4.16 | 105.66 |
| CS4W025 | 2.33 | 59.18 | CS4W360 | 4.10 | 104.14 |
| CS4W030 | 2.32 | 58.92 | | | |
| CS4W040 | 2.30 | 58.42 | | | |
| CS4W050 | 3.09 | 78.48 | CR4W020 | 2.38 | 60.45 |
| CS4W060 | 2.96 | 75.18 | CR4W025 | 2.33 | 59.18 |
| CS4W080 | 2.73 | 69.34 | CR4W030 | 2.32 | 58.92 |
| CS4W100 | 5.48 | 139.19 | CR4W040 | 2.30 | 58.42 |
| CS4W120 | 5.25 | 133.35 | CR4W050 | 3.09 | 78.48 |
| CS4W140 | 5.10 | 129.54 | CR4W060 | 2.96 | 75.18 |
| CS4W160 | 4.85 | 123.19 | CS4W080 | 2.73 | 69.34 |
| CS4W180 | 4.60 | 116.84 | CR4W100 | 5.48 | 139.19 |
| CS4W200 | 4.38 | 111.25 | CR4W120 | 5.25 | 133.35 |

6. Standard Sensor Installation

- Lubricate the sensor O-rings with a silicone lubricant (e.g. GE silicone compound #G632 or equivalent). Do not use any petroleum based lubricant that will attack the O-rings.
- Using an alternating/twisting motion, lower the sensor into the fitting, making sure the installation arrows on the black cap are pointing in the direction of flow, **see Figure A.**
- Engage one thread of the sensor cap then turn the sensor until the alignment tab is seated in the fitting notch. **Hand tighten the sensor cap. DO NOT** use any tools on the sensor cap or the cap threads and/or fitting flange threads will be damaged, **see Figure B.**

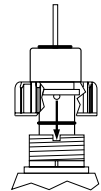
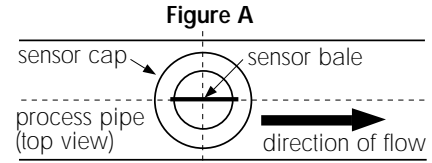

7. K-Factors

The **K-Factor** is the number of pulses the sensor will generate for each engineering unit of fluid which passes. They are listed in U.S. gallons and in liters. For example, in a 1 inch PVC pipe, the paddlewheel generates 352.435 pulses per gallon of fluid passing the rotor. K-Factors are listed for pipes up to 12 inch. For pipes over 12 inch, consult your +GF+ SIGNET distributor.

| PIPE SIZE | +GF+ SIGNET FITTING TYPE | ---K-FACTOR--- | |
|--|--------------------------|----------------|---------|
| | | U.S. GAL | LITERS |
| SCH 80 PVC TEES FOR SCH 80 PVC PIPE | | | |
| 1/2 IN. | PV8T005 | 991.706 | 262.010 |
| 3/4 IN. | PV8T007 | 545.142 | 144.027 |
| 1 IN. | PV8T010 | 352.435 | 93.114 |
| 1 1/4 IN. | PV8T012 | 177.184 | 46.812 |
| 1 1/2 IN. | PV8T015 | 117.852 | 31.137 |
| 2 IN. | PV8T020 | 66.739 | 17.633 |
| 2 1/2 IN. | PV8T025 | 42.994 | 11.359 |
| 3 IN. | PV8T030 | 26.652 | 7.041 |
| 4 IN. | PV8T040 | 15.006 | 3.964 |
| SCH 80 CPVC TEES FOR SCH 80 CPVC PIPE | | | |
| 1/2 IN. | CPV8T005 | 991.706 | 262.010 |
| 3/4 IN. | CPV8T007 | 545.142 | 144.027 |
| 1 IN. | CPV8T010 | 352.435 | 93.114 |
| 1 1/4 IN. | CPV8T012 | 177.184 | 46.812 |
| 1 1/2 IN. | CPV8T015 | 117.852 | 31.137 |
| SCH 80 PVC SADDLES ON SCH 80 PVC PIPE | | | |
| 2 IN. | PV8S020 | 66.739 | 17.633 |
| 2 1/2 IN. | PV8S025 | 42.994 | 11.359 |
| 3 IN. | PV8S030 | 26.652 | 7.041 |
| 4 IN. | PV8S040 | 15.006 | 3.964 |
| 6 IN. | PV8S060 | 8.325 | 2.199 |
| 8 IN. | PV8S080 | 5.016 | 1.325 |
| SCH 80 PVC SADDLE ON SCH 40 PVC PIPE | | | |
| 2 IN. | PV8S020 | 54.700 | 14.452 |
| 2 1/2 IN. | PV8S025 | 37.159 | 9.817 |
| 3 IN. | PV8S030 | 23.697 | 6.261 |
| 4 IN. | PV8S040 | 13.456 | 3.555 |
| 6 IN. | PV8S060 | 7.459 | 1.971 |
| 8 IN. | PV8S080 | 4.529 | 1.197 |
| CARBON STEEL TEES ON SCH 40 PIPE | | | |
| 1/2 IN. | CS4T005 | 756.000 | 199.736 |
| 3/4 IN. | CS4T007 | 438.690 | 115.902 |
| 1 IN. | CS4T010 | 286.784 | 75.768 |
| 1 1/4 IN. | CS4T012 | 121.218 | 32.026 |
| 1 1/2 IN. | CS4T015 | 91.139 | 24.079 |
| 2 IN. | CS4T020 | 54.468 | 14.391 |
| STAINLESS STEEL TEES ON SCH 40 PIPE | | | |
| 1/2 IN. | CR4T005 | 734.200 | 193.976 |
| 3/4 IN. | CR4T007 | 412.100 | 108.877 |
| 1 IN. | CR4T010 | 252.700 | 66.764 |
| 1 1/4 IN. | CR4T012 | 128.120 | 33.849 |
| 1 1/2 IN. | CR4T015 | 77.320 | 20.428 |
| 2 IN. | CR4T020 | 45.780 | 12.095 |

| PIPE SIZE | +GF+ SIGNET FITTING TYPE | ---K-FACTOR--- | |
|---|--------------------------|----------------|--------|
| | | U.S. GAL | LITERS |
| GALVANIZED IRON TEES ON SCH 40 PIPE | | | |
| 1 IN. | IR4T010 | 213.009 | 56.277 |
| 1 1/4 IN. | IR4T012 | 127.746 | 33.751 |
| 1 1/2 IN. | IR4T015 | 94.401 | 24.941 |
| 2 IN. | IR4T020 | 59.420 | 15.699 |
| CARBON STEEL WELDOLETS ON SCH 40 PIPE | | | |
| 2 1/2 IN. | CS4W025 | 37.600 | 9.934 |
| 3 IN. | CS4W030 | 24.340 | 6.431 |
| 4 IN. | CS4W040 | 13.920 | 3.678 |
| 5 IN. | CS4W050 | 10.860 | 2.869 |
| 6 IN. | CS4W060 | 7.520 | 1.987 |
| 8 IN. | CS4W080 | 4.340 | 1.147 |
| 10 IN. | CS4W100 | 2.760 | 0.729 |
| 12 IN. | CS4W120 | 1.940 | 0.513 |
| STAINLESS STEEL WELDOLETS ON SCH 40 PIPE | | | |
| 2 1/2 IN. | CR4W025 | 37.600 | 9.934 |
| 3 IN. | CR4W030 | 24.340 | 6.431 |
| 4 IN. | CR4W040 | 13.920 | 3.678 |
| 5 IN. | CR4W050 | 10.860 | 2.869 |
| 6 IN. | CR4W060 | 7.520 | 1.987 |
| 8 IN. | CR4W080 | 4.340 | 1.147 |
| 10 IN. | CR4W100 | 2.760 | 0.729 |
| 12 IN. | CR4W120 | 1.940 | 0.513 |
| SCH 80 IRON SADDLES ON SCH 80 PIPE | | | |
| 2 IN. | IR8S020 | 64.720 | 17.099 |
| 2 1/2 IN. | IR8S025 | 42.480 | 11.223 |
| 3 IN. | IR8S030 | 26.420 | 6.980 |
| 4 IN. | IR8S040 | 14.700 | 3.884 |
| 5 IN. | IR8S050 | 12.180 | 3.218 |
| 6 IN. | IR8S060 | 8.440 | 2.230 |
| 8 IN. | IR8S080 | 4.900 | 1.295 |
| 10 IN. | IR8S100 | 3.060 | 0.808 |
| 12 IN. | IR8S120 | 2.160 | 0.571 |
| SCH 80 IRON SADDLE ON SCH 40 PIPE | | | |
| 2 IN. | IR8S020 | 53.640 | 14.172 |
| 2 1/2 IN. | IR8S025 | 37.600 | 9.934 |
| 3 IN. | IR8S030 | 23.220 | 6.135 |
| 4 IN. | IR8S040 | 13.260 | 3.503 |
| 5 IN. | IR8S050 | 11.040 | 2.917 |
| 6 IN. | IR8S060 | 7.240 | 1.913 |
| 8 IN. | IR8S080 | 4.400 | 1.162 |
| 10 IN. | IR8S100 | 2.800 | 0.740 |
| 12 IN. | IR8S120 | 1.980 | 0.523 |

| PIPE SIZE | +GF+ SIGNET FITTING TYPE | ---K-FACTOR--- | |
|---|--------------------------|----------------|---------|
| | | U.S. GAL | LITERS |
| COPPER/BRONZE BRAZOLETS ON SCH 40 PIPE | | | |
| 2 1/2 IN. | BR4B025 | 37.600 | 9.934 |
| 3 IN. | BR4B030 | 24.340 | 6.431 |
| 4 IN. | BR4B040 | 13.920 | 3.678 |
| 5 IN. | BR4B050 | 10.860 | 2.869 |
| 6 IN. | BR4B060 | 7.520 | 1.987 |
| 8 IN. | BR4B080 | 4.340 | 1.147 |
| 10 IN. | BR4B100 | 2.760 | 0.729 |
| 12 IN. | BR4B120 | 1.940 | 0.513 |
| BRONZE TEES ON SCH 40 PIPE | | | |
| 1 IN. | BR4T010 | 213.009 | 56.277 |
| 1 1/4 IN. | BR4T012 | 127.746 | 33.751 |
| 1 1/2 IN. | BR4T015 | 94.401 | 24.941 |
| 2 IN. | BR4T020 | 59.420 | 15.699 |
| COPPER PIPE W/COPPER INSTALLATION FITTINGS | | | |
| 1/2 IN. SK K | CUKT005 | 917.844 | 242.495 |
| 1/2 IN. SK L | | 858.217 | 226.742 |
| 3/4 IN. SK K | CUKT007 | 428.270 | 113.149 |
| 3/4 IN. SK L | | 385.737 | 101.912 |
| 1 IN. SK K | CUKT010 | 256.430 | 67.749 |
| 1 IN. SK L | | 241.639 | 63.841 |
| 1 1/4 IN. SK K | CUKT012 | 176.437 | 46.615 |
| 1 1/4 IN. SK L | | 170.902 | 45.152 |
| 1 1/2 IN. SK K | CUKT015 | 115.690 | 30.565 |
| 1 1/2 IN. SK L | | 112.030 | 29.598 |
| 2 IN. SK K | CUKT020 | 63.385 | 16.746 |
| 2 IN. SK L | | 61.735 | 16.310 |

Conversion Formulas:

1 U.S. gallon = 0.003785 cubic meters
 0.000003069 Acre feet
 8.3454 pounds of water

K-Factors DIN Pipes

| PIPE SIZE | +GF+ SIGNET FITTING TYPE | ---K-FACTOR--- | | CODE | PIPE SIZE | +GF+ SIGNET FITTING TYPE | ---K-FACTOR--- | | CODE |
|---|--------------------------|----------------|---------|-------------|---|--------------------------|----------------|---------|-------------|
| | | U.S. GAL | LITER | | | | U.S. GAL | LITER | |
| POLYPROPYLENE FITTINGS (DIN/ISO AND BS AND ANSI) | | | | | PVC FITTINGS (DIN/ISO) - EUROPE ONLY | | | | |
| DN 15 | PPMT005 | 952.870 | 251.749 | 198.150.522 | DN 15 | PVMT005 | 972.366 | 256.900 | 198.150.480 |
| DN 20 | PPMT007 | 563.100 | 148.771 | 198.150.523 | DN 20 | PVMT007 | 485.691 | 128.320 | 198.150.481 |
| DN 25 | PPMT010 | 291.604 | 77.042 | 198.150.524 | DN 25 | PVMT010 | 297.274 | 78.540 | 198.150.482 |
| DN 32 | PPMT012 | 169.222 | 44.709 | 198.150.525 | DN 32 | PVMT012 | 170.249 | 44.980 | 198.150.483 |
| DN 40 | PPMT015 | 103.897 | 27.450 | 198.150.526 | DN 40 | PVMT015 | 103.709 | 27.400 | 198.150.484 |
| DN 50 | PPMT020 | 60.789 | 16.060 | 198.150.527 | DN 50 | PVMT020 | 59.500 | 15.720 | 198.150.485 |
| DN 65 | PPMT025 | 41.498 | 10.964 | 198.150.560 | DN 65 | PVMT025 | 34.973 | 9.240 | 198.150.538 |
| DN 80 | PPMT030 | 26.786 | 7.077 | 198.150.561 | DN 80 | PVMT030 | 24.981 | 6.600 | 198.150.539 |
| DN 100 | PPMT040 | 17.415 | 4.601 | 198.150.562 | DN 100 | PVMT040 | 16.275 | 4.300 | 198.150.540 |
| DN 125 | PPMT050 | 10.168 | 2.686 | 198.150.563 | DN 150 | PVMT060 | 8.176 | 2.160 | 198.150.543 |
| DN 150 | PPMT060 | 7.312 | 1.932 | 198.150.564 | DN 200 | PVMT080 | 4.088 | 1.080 | 198.150.545 |
| DN 200 | PPMT080 | 3.995 | 1.055 | 198.150.565 | | | | | |
| PVDF FITTINGS (DIN/ISO AND BS AND ANSI) | | | | | | | | | |
| DN 15 | SFMT005 | 827.257 | 218.562 | 198.150.529 | | | | | |
| DN 20 | SFMT007 | 489.869 | 129.424 | 198.150.530 | | | | | |
| DN 25 | SFMT010 | 283.554 | 74.915 | 198.150.531 | | | | | |
| DN 32 | SFMT012 | 158.588 | 41.899 | 198.150.532 | | | | | |
| DN 40 | SFMT015 | 86.980 | 22.980 | 198.150.533 | | | | | |
| DN 50 | SFMT020 | 50.385 | 13.312 | 198.150.534 | | | | | |
| DN 65 | SFMT025 | 36.133 | 9.546 | 198.150.571 | | | | | |
| DN 80 | SFMT030 | 24.715 | 6.530 | 198.150.572 | | | | | |
| DN 100 | SFMT040 | 16.120 | 4.259 | 198.150.573 | | | | | |
| DN 125 | SFMT050 | 8.862 | 2.341 | 198.150.574 | | | | | |
| DN 150 | SFMT060 | 6.454 | 1.705 | 198.150.575 | | | | | |
| DN 200 | SFMT080 | 4.072 | 1.076 | 198.150.576 | | | | | |

8. Order Information

| | | | | | | | | | | | |
|--------------------------------|----------------|----------------|----------------|--------------------------|-------------|---|---|----------------|----------------|----------------|-------------|
| Standard 2536 Low Flow Sensors | | | | | | +GF+ SIGNET 3-8512-XX Integral Sensor Accessories | | | | | |
| All O-rings are Viton® | | | | | | | | | | | |
| Order No. | Housing | Rotor Pin | Rotor | Pipe Size | Code | Order No. | Description | | | | Code |
| 3-2536-P0 | Polypro. | Titanium | PVDF (black) | 0.5 to 4.0 in. | 198 840 143 | 3-8011 | Integral sensor mounting kit with 1/2 in. NPT ports | | | | 198 864 500 |
| 3-2536-P1 | Polypro. | Titanium | PVDF (black) | 5.0 to 8.0 in. | 198 840 144 | 3-8011-D | Integral sensor mounting kit with PG13.5/DIN ports | | | | 198 864 501 |
| 3-2536-P2 | Polypro. | Titanium | PVDF (black) | 10 to 36 in. | 198 840 145 | +GF+ SIGNET 3-8512-XX Integral Sensors | | | | | |
| 3-2536-V0 | PVDF (natural) | Hastelloy C | PVDF (natural) | 0.5 to 4.0 in. | 198 840 146 | All O-rings are Viton® | | | | | |
| 3-2536-V1 | PVDF (natural) | Hastelloy C | PVDF (natural) | 5.0 to 8.0 in. | 198 840 147 | Order No. | Housing | Rotor Pin | Rotor | Pipe Size | Code |
| 3-2536-T0 | PVDF (natural) | PVDF (natural) | PVDF (natural) | 0.5 to 4.0 in. | 198 840 149 | 3-8512-P0 | Polypro. | Titanium | PVDF (black) | 0.5 to 4.0 in. | 198 864 513 |
| Accessories | | | | | | 3-8512-P1 | Polypro. | Titanium | PVDF (black) | 5.0 to 8.0 in. | 198 864 514 |
| Order No. | Material | Code | Order No. | Material | Code | 3-8512-V0 | PVDF (natural) | Hastelloy C | PVDF (natural) | 0.5 to 4.0 in. | 198 864 516 |
| Rotors | | | Rotor Pin | | | 3-8512-T0 | PVDF (natural) | PVDF (natural) | PVDF (natural) | 0.5 to 4.0 in. | 198 864 518 |
| 3-2536.320 | PVDF (black) | 198 820 052 | M1546-1 | Titanium | 198 801 182 | | | | | | |
| 3-2536.321 | PVDF (natural) | 198 820 054 | M1546-2 | Hastelloy C | 198 801 183 | | | | | | |
| + Shaft | | | M1546-3 | Tantalum | 198 820 014 | | | | | | |
| | | | M1546-4 | 316 SS | 198 820 015 | | | | | | |
| | | | P51545 | Ceramic | 198 820 016 | | | | | | |
| | | | 3-2536.321 | PVDF (natural) | 198 820 054 | | | | | | |
| | | | + Rotor | | | | | | | | |
| Order No. | | | | | | | | | | | |
| O-Rings | Material | Code | Order No. | Description | Code | | | | | | |
| 1220-0021 | Viton® (std.) | 198 801 186 | P31542-2 | Sensor cap, PP | 198 840 232 | | | | | | |
| 1224-0021 | EPR | 198 820 006 | P31536 | Plug, PP | 198 840 201 | | | | | | |
| 1228-0021 | Kalrez | 198 820 007 | P31536-2 | Plug, PVDF with std. cap | 198 840 202 | | | | | | |

9. Rotor Replacement Procedure

- To remove the rotor, insert a small screwdriver between the rotor and the ear of the sensor.
- Twist the screwdriver blade to flex the ear outward enough to remove one end of the rotor and pin. **DO NOT** flex the ear any more than necessary! If it breaks, the sensor cannot be repaired.
- Install the new rotor by inserting one ear into the hole, then flex the opposite ear back enough to slip rotor into place.

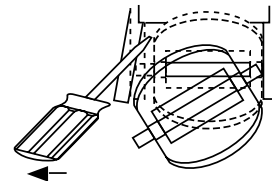

10. Specifications

General Data

Flow rate range: 0.1 to 6 m/s (0.3 to 20 ft/s)
 Linearity: $\pm 1\%$ of full range
 Repeatability: $\pm 0.5\%$ of full range

Pipe size range:
 • 2536 Sensor: 15 to 900 mm (0.5 to 36 in.)
 • 3-8512-XX Sensor: 15 to 200 mm (0.5 to 8 in.)

Cable length (2536): 7.6 m (25 ft), can splice up to 300 m (1000 ft)

Cable type: 2-conductor twisted-pair with shield

Materials

Sensor assembly: Various thermoplastics available. Refer to section 8 for details.

Electrical

Supply voltage: 3.3 to 24 VDC regulated
 Supply current: < 1.5 mA @ 3.3 - 6 VDC,
 < 20 mA @ 6 - 24 VDC
 Output type: Open collector transistor, sinking
 Output current: 10 mA max.

Quality Standards

- CE
- Manufactured under ISO 9001

Fluid Conditions

Pressure/Temperature Ratings

Polypropylene Body:

- 12.5 bar (180 psi) max. @ 20 °C (68 °F)
- 1.7 bar (25 psi) max. @ 85 °C (185 °F)

PVDF Body:

- 14 bar (200 psi) max @ 20 °C (68 °F)
- 1.7 bar (25 psi) max @ 85 °C (185 °F)

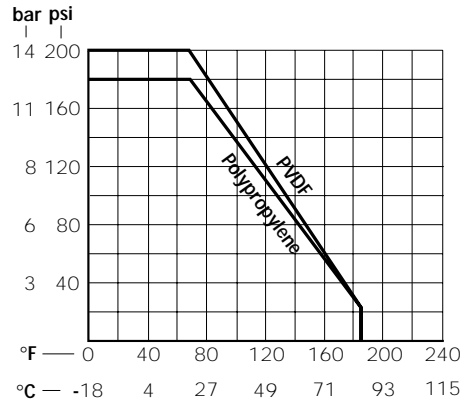

2536 Dimensions

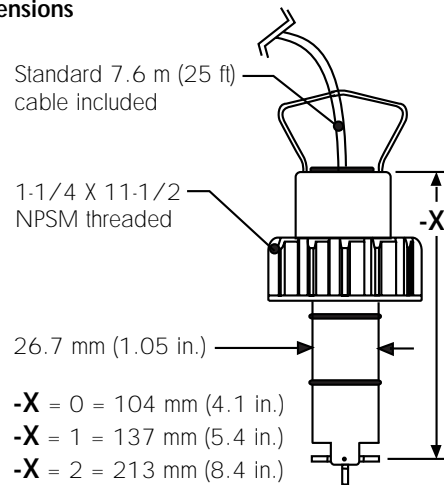

The last digit (X) in the sensor's part number represents the sensor's overall length

+GF+ SIGNET

Signet Scientific Company, 3401 Aerojet Avenue, El Monte, CA 91731-2882 U.S.A. • Tel. (626) 571-2770 • Fax (626) 573-2057
 For Worldwide Sales and Service, visit our website: www.gfsignet.com • Or call (in the U.S.): (800) 854-4090